

Swedish Judo Open 2018 2018-09-22 Haninge M21-66

Competitors: 9

1. Philip SJÖLANDER, SWE (1.dan)

A

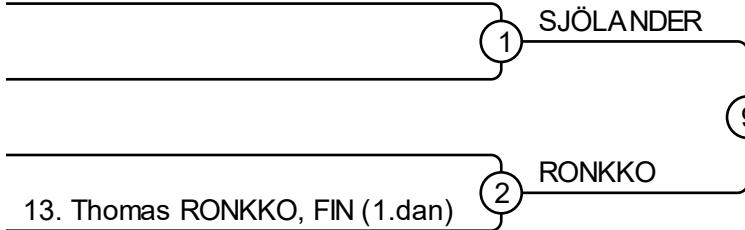

B

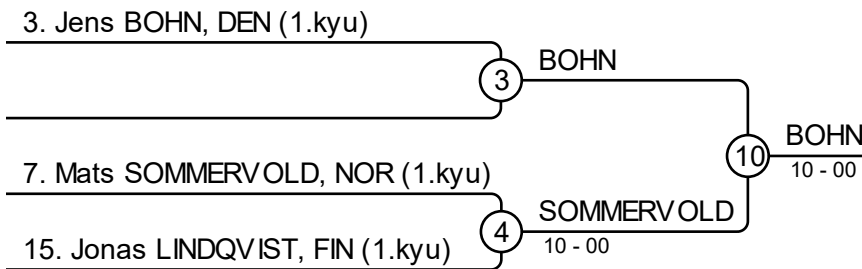

C

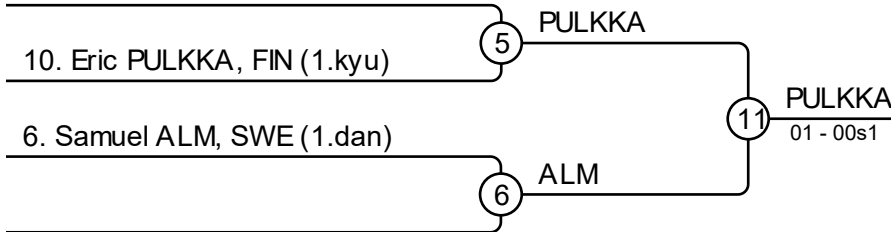

D

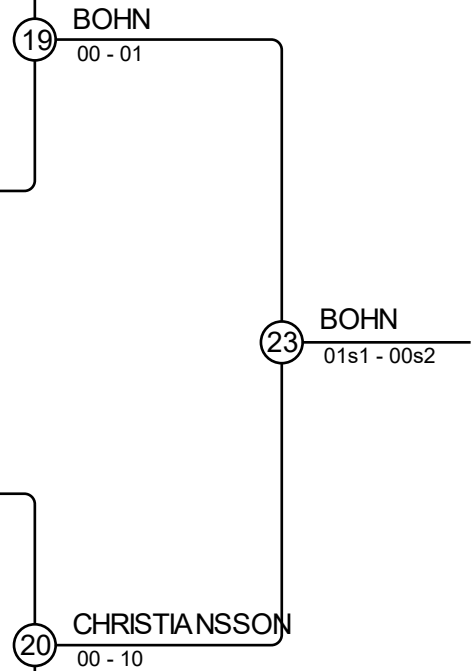
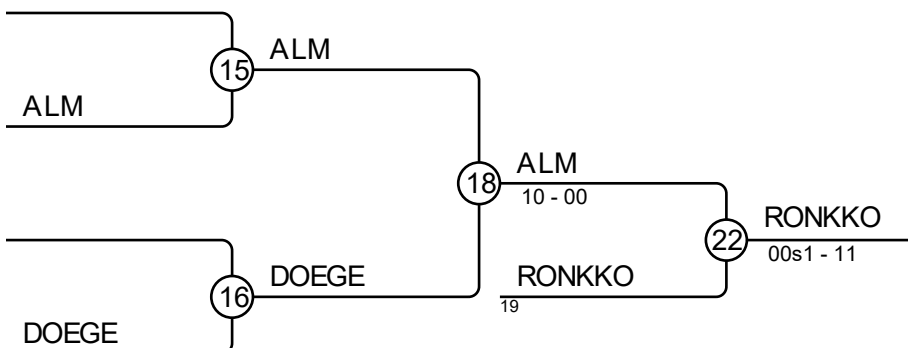
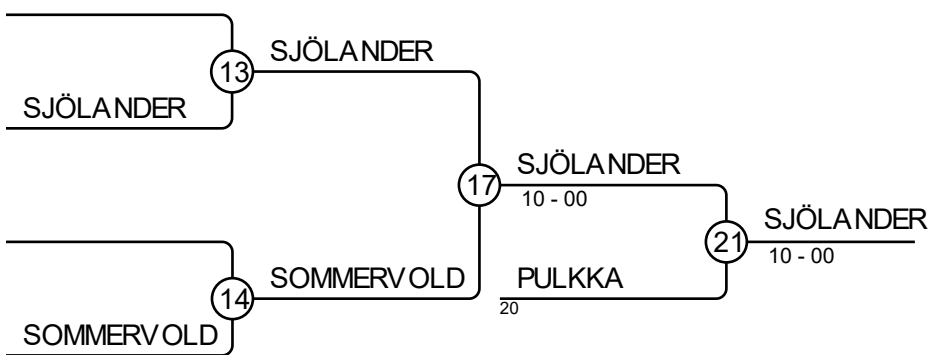
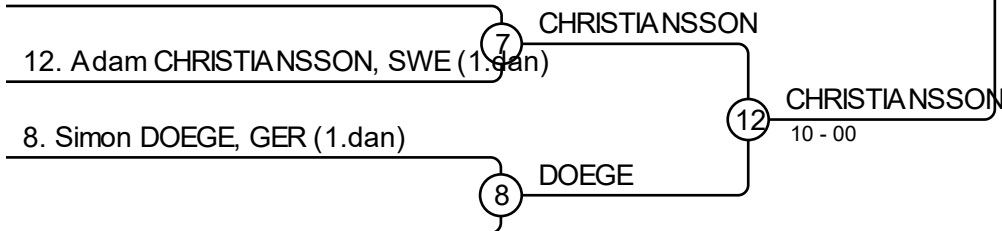

Results

Pos	Name
1	Jens BOHN, DEN
2	Adam CHRISTIANSSON, SWE
3	Philip SJÖLANDER, SWE
3	Thomas RONKKO, FIN
5	Eric PULKKA, FIN
5	Samuel ALM, SWE
7	Mats SOMMERVOLD, NOR
7	Simon DOEGE, GER